

## IR Receiver for High Data Rate PCM at 455 kHz

### Description

The TSOP7000 is a miniaturized receiver for infrared remote control and IR data transmission. PIN diode and preamplifier are assembled on lead frame, the epoxy package is designed as IR filter.

The demodulated output signal can directly be decoded by a microprocessor. The main benefit is the operation with high data rates and long distances.

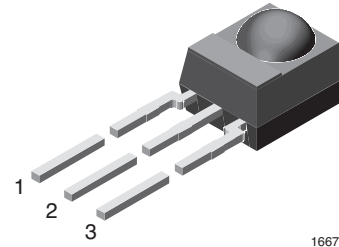

### Features

- Photo detector and preamplifier in one package
- Internal Bandfilter for PCM frequency
- Internal shielding against electrical field disturbance
- TTL and CMOS compatibility
- Output active low
- Small size package



### Special Features

- Data rate 20 kbit/s
- Supply voltage 2.7 - 5.5 V
- Short settling time after power on
- High envelope duty cycle can be received
- Enhanced immunity against disturbance from energy saving lamps

### Mechanical Data

#### Pinning:

1 = OUT, 2 = GND, 3 = V<sub>S</sub>

### Block Diagram

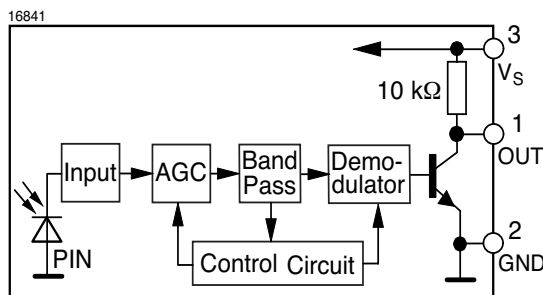

### Application Circuit

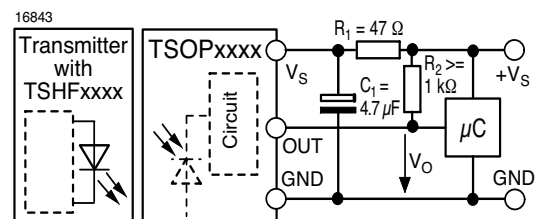

R<sub>1</sub> + C<sub>1</sub> recommended to suppress power supply disturbances.

R<sub>2</sub> optional for improved pulse forming.

### Absolute Maximum Ratings

Absolute Maximum Ratings

$T_{amb} = 25\text{ }^{\circ}\text{C}$ , unless otherwise specified

| Parameter                   | Test condition                        | Symbol      | Value                      | Unit               |
|-----------------------------|---------------------------------------|-------------|----------------------------|--------------------|
| Supply Voltage              | Pin 3                                 | $V_S$       | -0.3 to + 6.0              | V                  |
| Voltage at output to supply | Pin 1                                 | $V_S - V_O$ | -0.3 to<br>( $V_S + 0.3$ ) | V                  |
| Supply Current              | Pin 3                                 | $I_S$       | 5                          | mA                 |
| Output Voltage              | Pin 1                                 | $V_O$       | -0.3 to + 6.0              | V                  |
| Output Current              | Pin 1                                 | $I_O$       | 15                         | mA                 |
| Junction Temperature        |                                       | $T_j$       | 100                        | $^{\circ}\text{C}$ |
| Storage Temperature Range   |                                       | $T_{stg}$   | - 25 to + 85               | $^{\circ}\text{C}$ |
| Operating Temperature Range |                                       | $T_{amb}$   | - 25 to + 85               | $^{\circ}\text{C}$ |
| Soldering Temperature       | $t \leq 10\text{ s}$ , 1 mm from case | $T_{sd}$    | 260                        | $^{\circ}\text{C}$ |
| Power Consumption           |                                       | $P_{tot}$   | 30                         | mW                 |

### Electrical and Optical Characteristics

$T_{amb} = 25\text{ }^{\circ}\text{C}$ , unless otherwise specified

| Parameter                   | Test condition   | Symbol          | Min          | Typ.     | Max  | Unit                   |
|-----------------------------|--|-----------------|--------------|----------|------|------------------------|
| Supply Current (Pin 3)      | Dark ambient   | $I_{SD}$        |              | 2.0      | 2.7  | mA                     |
|                             | $E_v = 40\text{ klx}$ , sunlight   | $I_{SH}$        |              | 2.3      |      | mA                     |
| Supply Voltage (Pin 3)      |  | $V_S$           | 2.7          | 5        | 5.5  | V                      |
| Transmission Distance       | $\lambda_p = 870\text{ nm}$ ,<br>IR Diode TSHF5400,<br>$I_F = 300\text{ mA}$                     | $d_{max}$       |              | 20       |      | m                      |
|                             | $\lambda_p = 950\text{ nm}$ ,<br>IR Diode TSAL6400,<br>$I_F = 300\text{ mA}$                     | $d_{max}$       |              | 12       |      | m                      |
| Threshold Irradiance        | $\lambda_p = 870\text{ nm}$ ,<br>optical test signal of Fig.1                                    | $E_{e\ min}$    |              | 0.8      | 1.5  | $\text{mW}/\text{m}^2$ |
| Maximum Irradiance          | Optical test signal of Fig.1   | $E_{e\ max}$    | 30           |          |      | $\text{W}/\text{m}^2$  |
| Output Voltage Low (Pin 1)  | 1 k $\Omega$ external pull up resistor   | $V_{QL}$        |              |          | 100  | mV                     |
| Output Voltage High (Pin 1) | No external pull-up resistor   | $V_{QH}$        | $V_S - 0.25$ |          |      | V                      |
| Bandpass filter quality     |  | Q               |              | 10       |      |                        |
| Out-Pulse width tolerance   | Optical test signal of Fig.1,<br>$1.5\text{ mW}/\text{m}^2 \leq E_e \leq 30\text{ W}/\text{m}^2$ | $\Delta t_{po}$ | - 15         | + 5      | + 15 | $\mu\text{s}$          |
| Delay time of output pulse  | Optical test signal of Fig.1,<br>$E_e > 1.5\text{ mW}/\text{m}^2$                                | $t_{don}$       | 15           |          | 36   | $\mu\text{s}$          |
| Receiver start up time      | Valid data after power on  | $t_v$           |              | 50       |      | $\mu\text{s}$          |
| Falling time                | Leading edge of output pulse   | $t_f$           |              | 0.4      |      | $\mu\text{s}$          |
| Rise time                   | No external pull up resistor   | $t_r$           |              | 12       |      | $\mu\text{s}$          |
|                             | 1 k $\Omega$ external pull up resistor   | $t_r$           |              | 1.2      |      | $\mu\text{s}$          |
| Directivity                 | Angle of half transmission<br>distance   | $\phi_{1/2}$    |              | $\pm 45$ |      | deg                    |

## Typical Characteristics (Tamb = 25 °C unless otherwise specified)

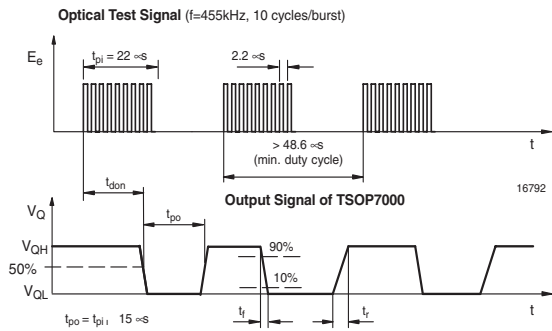

Figure 1. Output Function

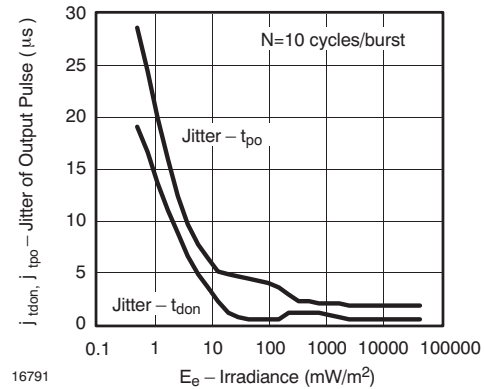

Figure 4. Jitter of Output Pulse

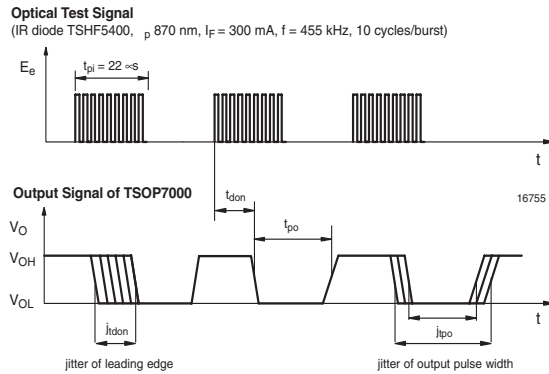

Figure 2. Output Function (mit Jitter)

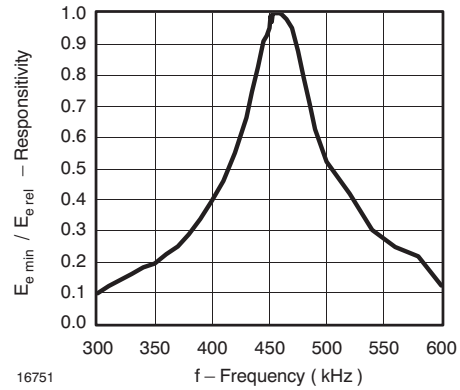

Figure 5. Frequency Dependence of Responsivity

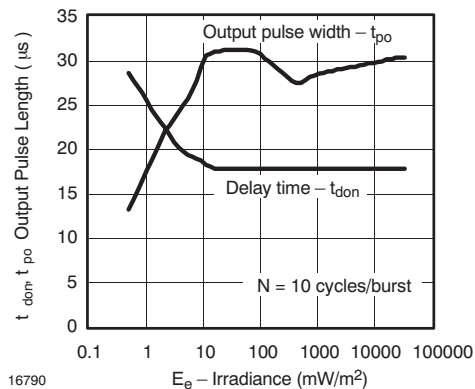

Figure 3. Output Pulse Diagram ( $t_{don}$ ,  $t_{po}$ )

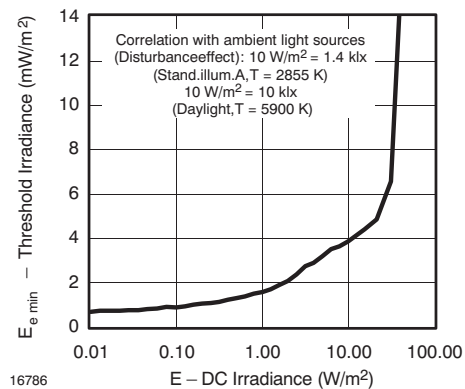

Figure 6. Sensitivity in Bright Ambient

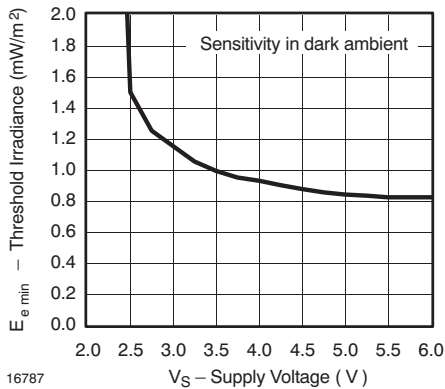

Figure 7. Sensitivity vs. Supply Voltage

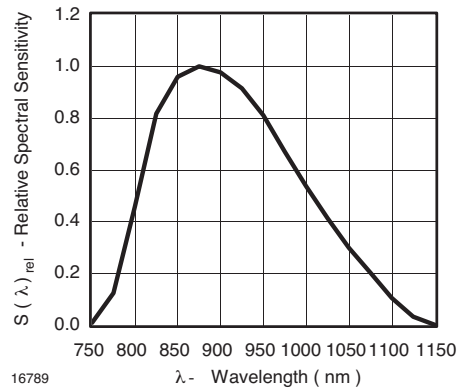

Figure 10. Relative Spectral Sensitivity vs. Wavelength

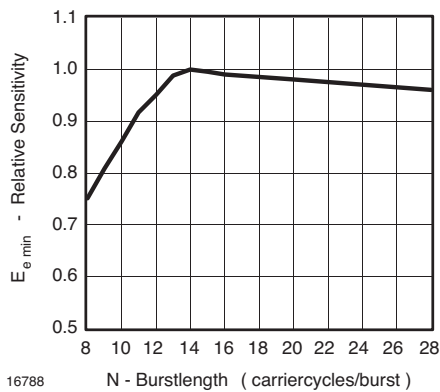

Figure 8. Rel. Sensitivity vs. Burstlength

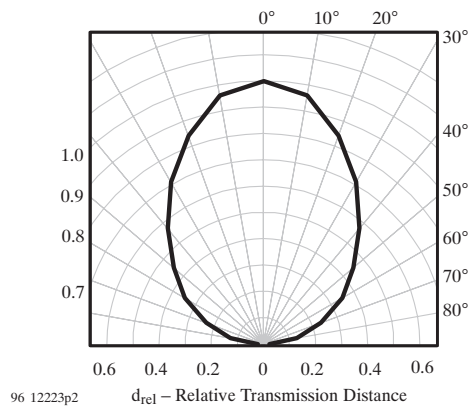

Figure 11. Directivity

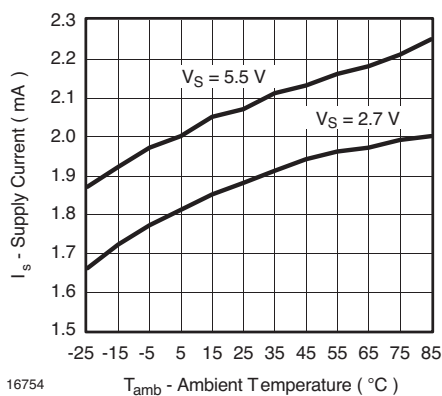

Figure 9. Supply Current vs. Ambient Temperature

## Recommendation for Suitable Data Formats

The circuit of the TSOP7000 is designed in that way that disturbance signals are identified and unwanted output pulses due to noise or disturbances are avoided. A bandpass filter, an automatic gain control and an integrator stage is used to suppress such disturbances. The distinguishing marks between data signal and disturbance are carrier frequency, burst length and the envelope duty cycle.

The data signal should fulfill the following conditions:

- The carrier frequency should be close to 455 kHz.
- The burstlength should be at least 22  $\mu\text{s}$  (10 cycles of the carrier signal) and shorter than 500  $\mu\text{s}$ .
- The separation time between two consecutive bursts should be at least 26  $\mu\text{s}$ .
- If the data bursts are longer than 500  $\mu\text{s}$  then the envelope duty cycle is limited to 25 %
- The duty cycle of the carrier signal (455 kHz) may be between 50 % (1.1  $\mu\text{s}$  pulses) and 10 % (0.2  $\mu\text{s}$  pulses). The lower duty cycle may help to save battery power.

## Package Dimensions in mm

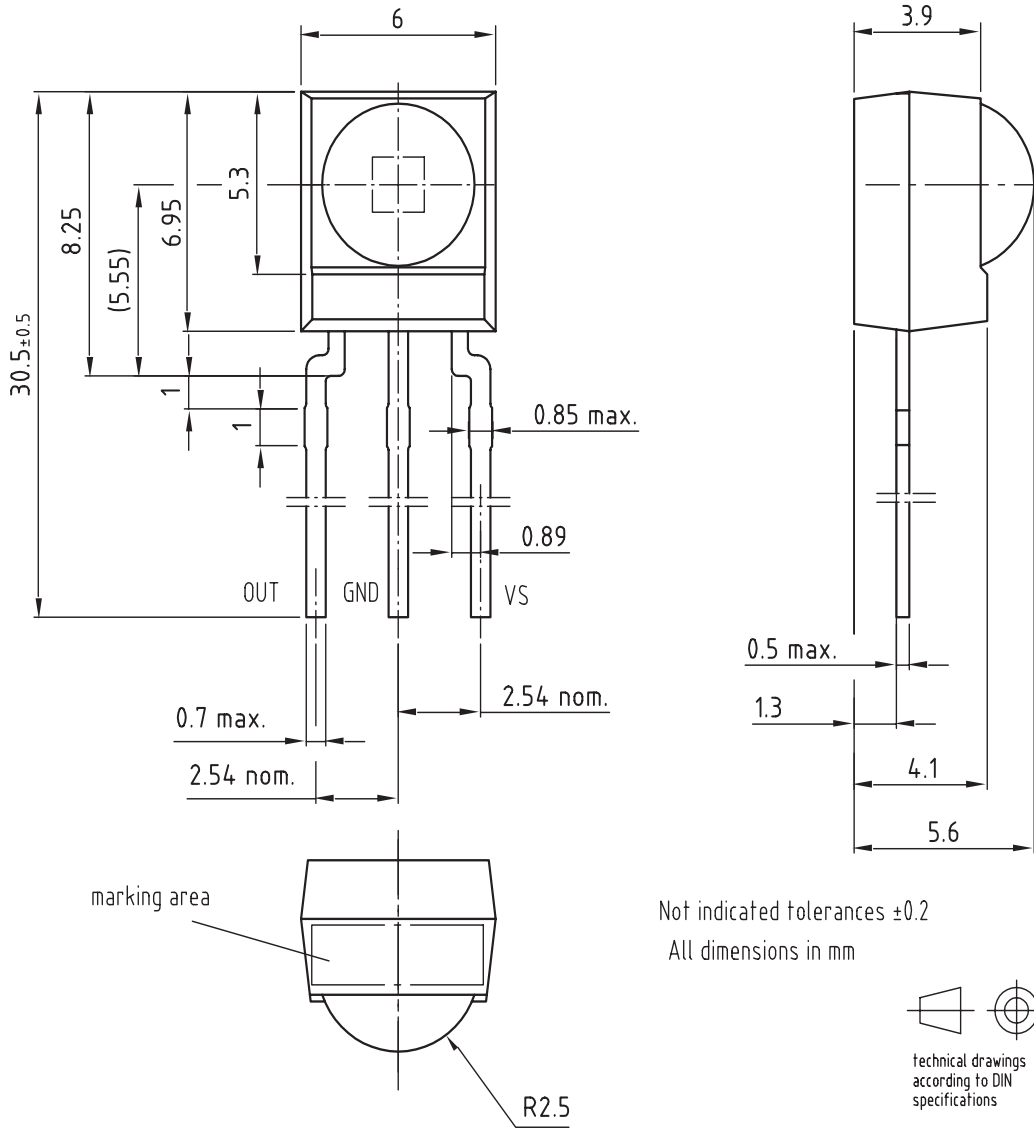

Drawing-No.: 6.550-5169.11-4  
Issue: 10; 08.06.04

16003



## Ozone Depleting Substances Policy Statement

It is the policy of Vishay Semiconductor GmbH to

1. Meet all present and future national and international statutory requirements.
2. Regularly and continuously improve the performance of our products, processes, distribution and operating systems with respect to their impact on the health and safety of our employees and the public, as well as their impact on the environment.

It is particular concern to control or eliminate releases of those substances into the atmosphere which are known as ozone depleting substances (ODSs).

The Montreal Protocol (1987) and its London Amendments (1990) intend to severely restrict the use of ODSs and forbid their use within the next ten years. Various national and international initiatives are pressing for an earlier ban on these substances.

Vishay Semiconductor GmbH has been able to use its policy of continuous improvements to eliminate the use of ODSs listed in the following documents.

1. Annex A, B and list of transitional substances of the Montreal Protocol and the London Amendments respectively
2. Class I and II ozone depleting substances in the Clean Air Act Amendments of 1990 by the Environmental Protection Agency (EPA) in the USA
3. Council Decision 88/540/EEC and 91/690/EEC Annex A, B and C (transitional substances) respectively.

Vishay Semiconductor GmbH can certify that our semiconductors are not manufactured with ozone depleting substances and do not contain such substances.

We reserve the right to make changes to improve technical design and may do so without further notice.

Parameters can vary in different applications. All operating parameters must be validated for each customer application by the customer. Should the buyer use Vishay Semiconductors products for any unintended or unauthorized application, the buyer shall indemnify Vishay Semiconductors against all claims, costs, damages, and expenses, arising out of, directly or indirectly, any claim of personal damage, injury or death associated with such unintended or unauthorized use.

Vishay Semiconductor GmbH, P.O.B. 3535, D-74025 Heilbronn, Germany  
Telephone: 49 (0)7131 67 2831, Fax number: 49 (0)7131 67 2423



### Notice

Specifications of the products displayed herein are subject to change without notice. Vishay Intertechnology, Inc., or anyone on its behalf, assumes no responsibility or liability for any errors or inaccuracies.

Information contained herein is intended to provide a product description only. No license, express or implied, by estoppel or otherwise, to any intellectual property rights is granted by this document. Except as provided in Vishay's terms and conditions of sale for such products, Vishay assumes no liability whatsoever, and disclaims any express or implied warranty, relating to sale and/or use of Vishay products including liability or warranties relating to fitness for a particular purpose, merchantability, or infringement of any patent, copyright, or other intellectual property right.

The products shown herein are not designed for use in medical, life-saving, or life-sustaining applications. Customers using or selling these products for use in such applications do so at their own risk and agree to fully indemnify Vishay for any damages resulting from such improper use or sale.